

A Two-Step Method for Estimating the Parameters of Induction Machine Models

Christopher Laughman*, Steven B. Leeb†, Leslie K. Norford‡, Steven R. Shaw§ and Peter R. Armstrong¶

*Mitsubishi Electric Research Laboratories
201 Broadway, Cambridge, MA 02139
email: laughman@merl.com

†Department of Electrical Engineering and Computer Science
Massachusetts Institute of Technology, Cambridge, MA 02139
email: sbleeb@mit.edu

‡Department of Architecture
Massachusetts Institute of Technology, Cambridge, MA 02139
email: lnorford@mit.edu

§Department of Electrical and Computer Engineering
Montana State University, Bozeman, MT 59717
email: sshaw@matrix.coe.montana.edu

¶Masdar Institute of Science and Technology, Abu Dhabi, United Arab Emirates
email: parmstrong@masdar.ae

Abstract—This paper describes and demonstrates a mathematical algorithm that can monitor the physical parameters of the motor solely by observing the stator electrical currents. This method uses measurements of transient stator currents to identify the parameters of an electromechanical model of the induction motor. These parameters are obtained from a relatively poor initial guess, which is constrained only to be within an order of magnitude of the physical parameters, by using a two-step strategy based upon nonlinear least-squares regression techniques. This makes the approach in this paper useful for diagnostic monitoring and energy scorekeeping. Experimental results are presented which demonstrate the effectiveness of this method on identifying the parameters of a 1 HP induction motor connected to a squirrel cage fan in an air-handling unit.

Index Terms—Induction machines, parameter estimation, fault diagnosis.

I. INTRODUCTION

Induction machines, which are central to modern commercial and industrial processes, are sometimes referred to as the “workhorses of modern industry.” Due to their importance, the control and condition monitoring of these machines have long been investigated. For many applications, it is very convenient to identify and track the parameters of an electromechanical model of the induction machine. Accurate estimates of the model parameters of the machine are essential to the construction of robust control algorithms, and valuable information

about some of machine faults can be inferred from changes in the estimated model parameters. Estimates of the model parameters can also be used to assist in probing the mechanical condition of the load connected to the shaft, e.g., for determining fan or pump performance. Motor parameters estimated from field observations can be used to diagnose the operating health of systems like heating, ventilating and air conditioning (HVAC) units while operating in the field. Reliable parameter estimates make it possible to use actuators like the motors in an HVAC plant as “sensors” for the electromechanical condition of the plant given only a set of electrical measurements.

A wide variety of modeling, signal processing, and control techniques have been developed to ensure that induction machines function reliably and can be serviced before causing equipment failure. Surveys that describe the scope of this existing research are presented in [1]–[3]. In general, the overall function of these methods can be described as using observations of the motor to find a set of parameter values for a suitable model that will accurately characterize the operation of the machine over the desired range of operating conditions.

This wide array of extant methods for parameter identification can largely be distinguished on the basis of three characteristics: the model of the induction machine used for parameter identification, the set of measurements of the induction machine’s behavior that are obtained, and the algorithm which is used to generate the parameter estimates for the given model from the information obtained by the given set of sensors. These methods can also be implemented either as “offline” or “online” processes [3]. In an offline process, the

Essential funding and support for this research was provided by the Grainger Foundation, the National Science Foundation, NASA Ames Research Center, NEMOmetrics, Inc., and the Office of Naval Research under the ESRDC program.

parameters of the machine are estimated either at the factory or in a preliminary commissioning step before the machine is installed at the site, while an online process uses *in situ* measurements obtained while the machine is operating in its specified function to estimate the parameters of the model. This paper focuses on the “online” approach to parameter identification as it is often desirable to identify the evolution of the machine parameters without removing the machine from service.

In experimental conditions where a great deal of information is required about the behavior of the machine, relatively large numbers of sensors may be used to measure the machine’s behavior, including the fluxes, voltages, currents, and position and/or speed [2]. While this approach can provide very accurate parameter estimates, large numbers of measurements may be prohibitively expensive and can also introduce unwanted uncertainty about the measurement reliability. Another approach, which uses a smaller number of measurements, adds additional hardware to excite the motor windings with specially designed signals that can yield particularly useful information about the machine parameters, e.g. [4]. While this approach still requires additional hardware, this hardware is often designed to be easily installed, as opposed to the full set of instrumentation that is required to measure all pertinent electrical variables.

Many parameter estimation algorithms for electric machines are designed in part to minimize the number of installed sensors, reducing the cost and maintenance burden for the sensors. Many of these methods rely upon measurements of the voltage and current at the stator windings, as well as the rotor speed [5], [6]. Many different parameter estimation approaches have been successfully deployed, including genetic algorithms [7], constrained least squares minimization [8], and nonlinear least squares [6]. Reference [6] estimates the load inertia J and the load torque τ_L in addition to the electrical parameters of the machine. Estimates of these load parameters can be used to monitor the condition of the load concurrently with the monitoring of the motor. Motivated by the desire to further reduce the number of sensors, speed-sensorless approaches attempt to estimate parameters without direct measurements of the mechanical shaft. For example, reference [9] estimates the parameters of an induction machine solely based on observations of the transient excitations of the electrical terminal variables. Shaft-sensorless techniques are desirable for smart-grid, energy scorekeeping, and diagnostic tracking applications, such as nonintrusive load monitoring [10].

One of the salient challenges in estimating the parameters of an induction machine model, such as the fifth-order model given in [11], is that the parameters are embedded in the observed currents and voltages in a highly nonlinear fashion. Successful parameter estimation algorithms typically require an initial guess which is very close to the actual parameter values [12]. To reduce the sensitivity of the parameter estimation method to the particular values of these initial guesses, this paper demonstrates an algorithm for using nonlinear least squares to estimate the machine parameters applied to reduce

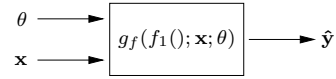

Fig. 1. The basic structure of the simulation process.

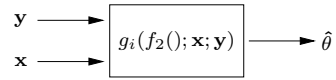

Fig. 2. The basic structure of the estimation process.

the susceptibility of nonlinear least squares to converge to a local minimum rather than the desired global minimum. Convergence of the nonlinear least squares algorithm is improved by using a “pre-estimation” technique [13], which both increases the effective convexity of the function and decreases the sensitivity of the algorithm on the particular value of the initial guess by adding an additional step in the algorithm. This research builds upon the initial description of pre-estimation provided in [13] and presents a novel example of the benefits of this approach to parameter estimation.

Following this introduction, the two-step approach used to identify the parameters of the electromechanical model of the induction machine from the observations of the stator current will be discussed in Section 2. Experimental results obtained by implementing this method and testing it on the stator currents observed on a 1-HP machine connected directly to the electric utility will be presented in Section 3. These results will be reviewed in Section 4.

II. TWO-STEP PARAMETER ESTIMATION METHOD

The parameter estimation method developed in this paper uses the processes of both simulation and estimation, as illustrated in Figures 1 and 2. The process of simulation (denoted in Figure 1 as g_f to represent the solution of the “forward problem”) generally uses a known functional mapping $f_1()$ to generate a set of predicted outputs \hat{y} from a set of measured inputs x , and the parameters θ which govern the behavior of this mapping are known in advance. In comparison, the process of parameter estimation, sometimes referred to as an “inverse problem” or g_i in Figure 2, uses a set of observations of both inputs x and outputs y to construct the functional mapping between the two sets of observations. The output of the inverse problem is thus the set of parameters $\hat{\theta}$ which best constructs this mapping.

Because the formulation of forward models is usually much more straightforward than inverse models, a variety of different approaches have been studied for the development of these inverse models. An obvious approach is the construction of the exact inverse mapping g_f^{-1} ; while the simplicity of this method is appealing, major problems in implementing such inverse mappings often arise due to nonlinearities, poor numerical conditioning, or other pathological behavior. Instead of directly inverting this model as in [6], an alternative approach for parameter identification used here embeds the forward model directly in the parameter estimation method, as illustrated in Figure 3.

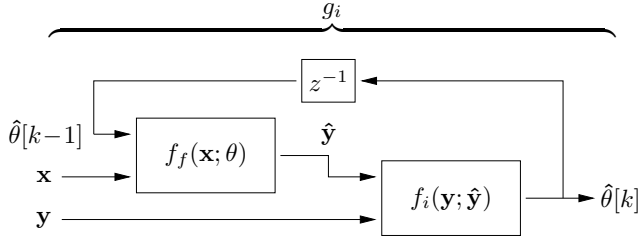

Fig. 3. Structure of an estimation method that incorporates a forward model.

This diagram illustrates the means by which the simulation is incorporated into the overall parameter estimation method g_i ; the overbrace g_i in Figure 3 signifies that the function g_i in this figure represents the corresponding function in Figure 2. The simulation routine is initialized with an initial guess for parameters θ_0 as well as the inputs to the system \mathbf{x} , the simulation is run, and then the resulting output of this simulation $\hat{\mathbf{y}}(\theta, \mathbf{x})$ is fed into the estimation routine f_i . This estimation routine compares the observed data vector \mathbf{y} and the output of the simulation $\hat{\mathbf{y}}(\theta, \mathbf{x})$, and computes a new parameter estimate $\theta[k]$, which is then fed back into the simulation routine. After the first iteration, the parameters θ of the simulation f_f are updated with the most recent parameter estimate $\hat{\theta}[k-1]$. This cycle is repeated until an exit condition is reached; ideally the difference $\mathbf{r}(\hat{\theta}) = \mathbf{y} - \hat{\mathbf{y}}(\hat{\theta}, \mathbf{x})$ is reduced below an established threshold, but other exit conditions typically include exceeding a set number of iterations, no change in the parameters, and no change in the evaluated residual.

The block denoted f_i uses the Levenberg-Marquardt (LM) algorithm [14] to generate and iteratively refine the parameter estimates based upon the residual $\mathbf{r}(\hat{\theta})$. This algorithm is useful because it uses information from previous steps in updating the parameter estimates, and can generate parameter estimates quickly if the problem is formulated correctly. The unmodified LM algorithm does not typically generate good parameter estimates in a power system application, however, because the residual being minimized, i.e. $r(\theta) = \|\mathbf{y} - \hat{\mathbf{y}}(\theta, \mathbf{x})\|_2^2$, has a large number of local minima due to the sinusoidal excitation of the system. Because the LM algorithm uses the gradient of the residual to update the estimates of the parameters, the parameter estimates produced often represent the optimum parameter estimate in the region about the initial guess, rather than the globally optimum parameter estimate.

Pre-estimation of the initial guess can be used to improve the convergence of nonlinear least squares [13]. This technique seeks to exploit the fact that a high-quality initial guess will accelerate and improve the performance of nonlinear least squares for many parameter identification problems. The structure of this approach to parameter estimation can best be seen in Figure 4. The poor initial guesses are provided to the system as $\hat{\theta}_0$, and are refined through pre-estimation algorithm $g_{i,pre}$ to be pre-estimates $\hat{\theta}_{pre}$. This high-quality initial guess

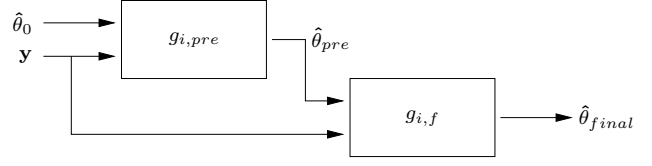

Fig. 4. Block diagram illustrating the structure of the pre-estimation method.

is then iteratively refined by the final parameter algorithm $g_{i,f}$ to obtain the final parameter estimates $\hat{\theta}_{final}$. In effect, the use of pre-estimates trades computational time and complexity for the quality of the initial guess. Each block in this diagram has the form illustrated in Figure 3; that is, each of these blocks has both an embedded forward model f_f that generates a set of outputs given the current guess for the parameters, and a Levenberg-Marquardt block f_i , which iteratively refines the parameters. For clarity, the pre-estimation and final estimation steps will be illustrated separately.

The motor model (represented as f_f in Figure 3) used in the pre-estimation block $g_{i,pre}$ and in the estimation block $g_{i,f}$ is the fifth-order model of the induction machine [11]. The mechanical load coupled to the shaft was modeled with two parameter model, consisting of an inertia and a damping term. This approach is reasonable for many diagnostic applications, e.g. fans and pumps in HVAC systems. This model is most conveniently represented in the reference frame rotating synchronously with the stator voltages [15], i.e.

$$\begin{bmatrix} f_d \\ f_q \\ f_0 \end{bmatrix} = \begin{bmatrix} \cos(\theta) & \cos(\theta - \frac{2\pi}{3}) & \cos(\theta + \frac{2\pi}{3}) \\ -\sin(\theta) & -\sin(\theta - \frac{2\pi}{3}) & -\sin(\theta + \frac{2\pi}{3}) \\ 1/2 & 1/2 & 1/2 \end{bmatrix} \begin{bmatrix} f_a \\ f_b \\ f_c \end{bmatrix}, \quad (1)$$

or, in a more compact form,

$$\mathbf{f}_{dq0} = \mathbf{T}(\theta)\mathbf{f}_{abc}, \quad (2)$$

where $\theta = \omega_e t$ in this application.

After applying this d-q transformation to the equations describing the dynamics of the induction machine, the machine can be described by the following equations:

$$\frac{d\lambda_{qs}}{dt} = v_{qs} - R_s i_{qs} - \omega_e \lambda_{ds} \quad (3)$$

$$\frac{d\lambda_{ds}}{dt} = v_{ds} - R_s i_{ds} + \omega_e \lambda_{qs} \quad (4)$$

$$\frac{d\lambda_{qr}}{dt} = v_{qr} - R_r i_{qr} - (\omega_e - p\omega_r)\lambda_{dr} \quad (5)$$

$$\frac{d\lambda_{dr}}{dt} = v_{dr} - R_r i_{dr} + (\omega_e - p\omega_r)\lambda_{qr}. \quad (6)$$

where λ denotes the flux linkages with the rotor variables and parameters reflected to the stator, ω_e is the frequency of the stator excitation (i.e. the frequency of the drive voltage) in rad/s, and ω_r is the rotor speed in rad/s, and p is the number of pole pairs. The voltages v_{ds} and v_{qs} represent the driving voltages in most experimental applications, as v_{dr} and v_{qr} are set to zero due to the fact that the rotor bars are shorted

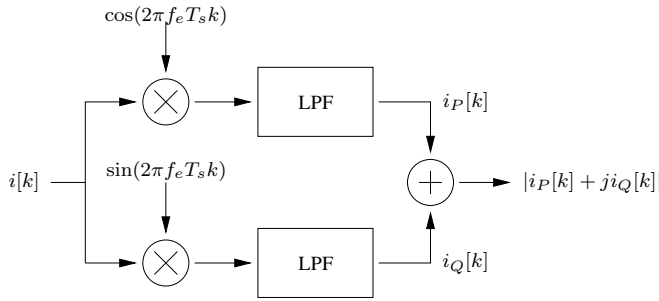

Fig. 5. Envelope extraction block.

together on a squirrel-cage machine. The flux linkages and the currents are related by the following equations:

$$\lambda_{qs} = L_{ls} i_{qs} + L_m (i_{qs} + i_{qr}) \quad (7)$$

$$\lambda_{ds} = L_{ls} i_{ds} + L_m (i_{ds} + i_{dr}) \quad (8)$$

$$\lambda_{qr} = L_{lr} i_{qr} + L_m (i_{qs} + i_{qr}) \quad (9)$$

$$\lambda_{dr} = L_{lr} i_{dr} + L_m (i_{ds} + i_{dr}). \quad (10)$$

The torque of electrical origin produced by the motor is given by

$$\tau_e = \frac{3}{2} p (\lambda_{qr} i_{dr} - \lambda_{dr} i_{qr}). \quad (11)$$

This torque τ_e is related to the mechanical load of the fan by the usual force balance equation,

$$\frac{d\omega_r}{dt} = \frac{1}{J} (\tau_e - \beta \omega_r^2). \quad (12)$$

The pre-estimation step was designed to compensate for the fact that the local minima in the residual are largely caused by the sinusoidal component of the current transient. The rejection of this sinusoidal or “carrier frequency” variation helps to eliminate the local minima that degrades the performance of the LM algorithm. Since the envelope of the motor current is sensitive to changes in many of the motor parameters [16], the envelope was extracted from the observed current data by processing the measured currents with a low-pass filter using a standard demodulation technique and Butterworth filters [17]. This technique has the effect of preserving the slow-moving envelope while eliminating the 60 Hz component of the signal. The cutoff frequency of the third-order Butterworth filters was set to 15 Hz.

Figure 6 illustrates the effect of this filter, as the envelope of the startup transient has been obtained from the input current and the sinusoidal component of the current signal has been eliminated. The sensitivity of this envelope to the motor parameters makes this an ideal preprocessing method from which parameter pre-estimates may be obtained.

Since all of the currents in the stator windings are nominally identical for a balanced machine except for phase shifts, the minimization was only performed against one phase of the stator current, referred to as phase A. All three of the voltages V_{AB} , V_{BC} , and V_{CA} were measured, however, to perform the

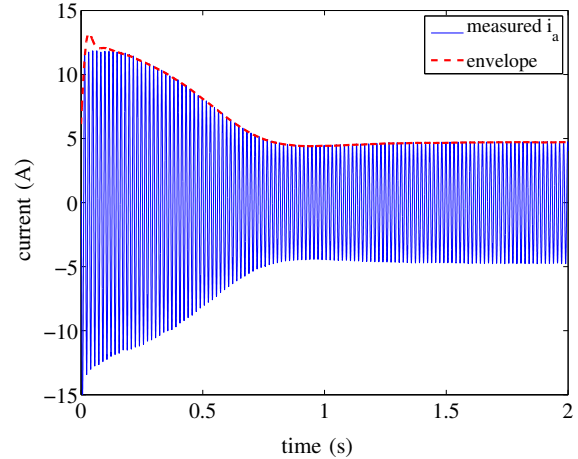

Fig. 6. Plot of the observed phase A motor current along with the preprocessed envelope of the current.

d-q transformation and obtain the voltages V_D and V_Q in the synchronous reference frame as required by Equations 3 and 4.

By incorporating this information from the pre-estimation filter, the first of the two estimation steps may be described. This first step, referred to in Figure 4 as $g_{i,pre}$, is illustrated in Figure 7. The user only needs to provide the set of observed voltages and currents, as well as the approximate set of initial guesses. Most of the initial guesses only need to be within an order of magnitude; the only parameter which must be known to any additional accuracy is the stator winding resistance. This parameter can be determined with a simple measurement when the induction machine is cold by an ohmmeter, and is used to constrain Levenberg-Marquardt’s adjustment of the remaining parameters.

The forward model f_f is first initialized with the initial guess of parameters $\hat{\theta}_{init}$ and the set of observed voltages \mathbf{v}_{obs} are input to the parameter estimation method. The forward model is then used to generate a set of predictions of the stator currents $\hat{\mathbf{i}}$. These currents are filtered to obtain the current envelope $\hat{\mathbf{i}}_{filt}$ and this filtered prediction is then compared to the the filtered set of observed currents $\mathbf{i}_{obs,filt}$. The difference between these two signals is then input to the LM algorithm, which generates a new estimate of the parameters $\hat{\theta}[k]$. This estimate $\hat{\theta}[k]$ of all of these parameters, except for the stator resistance, is then iteratively refined until the signal $\hat{\mathbf{i}}_{filt}$ closely approximates the signal $\mathbf{i}_{obs,filt}$ and the residual $r(\theta) = \|\mathbf{y}_{filt} - \hat{\mathbf{y}}_{filt}(\hat{\theta}, \mathbf{x})\|_2^2$ is minimized. The resulting set of parameters $\hat{\theta}$ that results after the iterations have stopped is equal to the set of parameter pre-estimates $\hat{\theta}_{pre}$.

It is important to note that the model parameters that are pre-estimated are not adequate to describe the unfiltered set of observations of the system; these pre-estimates are only intended to serve as improved initial guesses for the parameter estimation process for the unfiltered set of observations. In order to find the set of parameters that most accurately represents the unfiltered set of observations, a second step

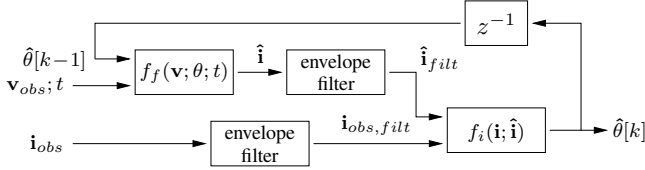

Fig. 7. Motor parameter estimation method: Step 1.

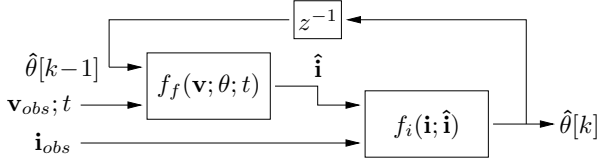

Fig. 8. Motor parameter estimation method: Step 2.

further refines the parameter estimates. In this second step, the simulation f_f is initialized with the improved pre-estimates $\hat{\theta}_{pre}$, rather than the set of rough initial guesses $\hat{\theta}_{init}$. All of the parameters, including the stator resistance, are iteratively adjusted using LM in this step to minimize the residual $r(\theta) = \|\mathbf{y} - \hat{\mathbf{y}}(\theta, \mathbf{x})\|_2^2$ to find the parameters which best describe the observed currents.

Figure 8 illustrates this second step. It is clear from the figure that the structure of the second step is very similar to the first step, with the key difference that neither the output of the simulation nor the observed currents are filtered. Because the parameter estimation method operates on this unfiltered data, the parameters that are iteratively refined will best characterize the performance of the system. Furthermore, because the initial guesses generated by the pre-estimation step are high quality, the parameter estimates generated by Levenberg-Marquardt are more likely to represent the global minimum, rather than a local minimum. Once the method converges, the set of parameters $\hat{\theta}$ are equal to the machine parameters $\hat{\theta}_{final}$.

In both parameter estimation steps, the performance of the standard Levenberg-Marquardt algorithm also depends on the treatment of a few specific numerical considerations. The first of these considerations pertains to the scaling of the parameters: widely spaced parameters, whose size varies over several orders of magnitude, can be very sensitive to the parameter corrections applied by the nonlinear least squares algorithm. For example, if the gradient of the loss function in the direction of one parameter K is quite steep, the corresponding adjustment to the parameters could cause a large change in another very small parameter, such as β . These large adjustments in β could consequently cause for the convergence of the method as other parameters are adjusted according to the new position on the loss function.

This problem can be mitigated by scaling the parameters in the motor simulation according to their expected magnitudes, which are relatively easy for a user to estimate. This will allow the minimization algorithm to change all of the parameters by the same order of magnitude; for example, if the true

parameters of the system are $\beta = 5 \times 10^{-6}$ and $K = 140$, scale factors of 10^{-6} and 100 would multiply the parameters β and K , respectively, inside of the simulation function, resulting in final parameter estimates of 5 and 1.4. This approach effectively stretches the residual space so that it makes all of the scales of the parameter gradients comparable.

Other important constraints were implemented to improve the performance of the minimization algorithm. One such constraint incorporates the fact that the parameters of the model cannot be negative, due to physical considerations. This constraint was implemented in this research by applying a sigmoid, or logistic, function to the parameters. The behavior of this function is given by

$$f(x) = \frac{1}{1 + e^{-\alpha x}}. \quad (13)$$

This constraint was implemented in much the same way as the scaling; the parameter estimates generated by nonlinear least squares were transformed using this sigmoid function, and the resulting transformed parameters were used in the motor simulation. This had the effect of transforming the constrained optimization problem, which ensures physically realistic parameter values, into an unconstrained parameter identification problem. Unlike the parameter scaling discussed previously, this constraint was only imposed during the pre-estimation step, as the parameter pre-estimates were sufficiently close to the final parameter estimates that this constraint was not needed during the final step.

The final numerical constraint imposed on the minimization method placed limitations on the size of the adjustment $\delta^{(i+1)} = \theta^{(i+1)} - \theta^{(i)}$ applied to the parameters after every iteration. Even after applying the appropriate scaling to the parameters, large gradients in the loss function can cause LM algorithm to take large parameter steps. If the loss function is globally convex, as is the case in linear problems, such an adjustment in the stepsize is useful since the gradient will be bigger as the distance from the minimum increases. This is not the case in nonlinear problems, however, and the resulting movement far away from the previous initial guess will not take advantage of the additional information that is often implicit in the initial guess for the parameters selected by the user.

This information can be incorporated into the minimization algorithm by imposing a set of linear constraints on the parameters, effectively placing a “rubber band” on the parameters so that they do not move far in consecutive iterations. This can be accomplished by adding an additional set of equations to the system of linearized equations that is solved at each step. If the system of equations that represents the linearized behavior of the nonlinear system at the current speed is written by $\nabla \mathbf{G}(\theta^{(i)}) \delta^{(i+1)} = \mathbf{G}(\theta^{(i)})$, then the additional constraint can be implemented by solving the simultaneous set of equations

$$\begin{bmatrix} \nabla \mathbf{G}(\theta^{(i)}) \\ \mathbf{I} \end{bmatrix} \delta^{(i+1)} = \begin{bmatrix} \mathbf{G}(\theta^{(i)}) \\ \gamma \frac{\delta^{(i)}}{\theta_0} \end{bmatrix} \quad (14)$$

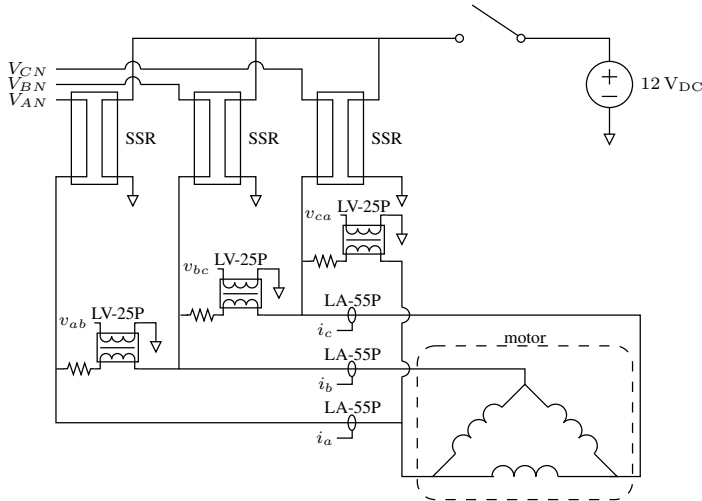

Fig. 9. Schematic diagram of the control and data acquisition system.

This technique is commonly known as regularization [18], and can be controlled by the size of the constant γ that multiplies the parameters. This parameter is often set by trial and error; values of γ which are too large prevent nonlinear least squares from adjusting the parameters at all, while values that are too small allow the parameters to change more than is desired. The implementation of regularization in the nonlinear least squares algorithm proved to be essential to obtaining useful parameters from the method.

III. EXPERIMENTAL RESULTS

The two-step method for estimating the parameters of the induction motor was experimentally tested on a 3-phase 208VAC 1-HP induction machine. This motor was designed to be used in air-handling units, and was loaded with a double-duct centrifugal fan with a typical flow rate of approximately 2300 cfm. The motor was also connected directly to the electric utility, rather than to a regulated AC power supply.

The currents into the stator windings were measured with a set of LEM LA-55P hall effect current transducers and the voltages across the stator windings were measured with LEM LV-25P voltage transducers. An Advantech PCI-1710 data acquisition card was used with a 2GHz Intel Xeon PC to collect the six channels of data corresponding to the three stator voltages and currents at a sampling rate of 14.28 kHz per channel. This relatively high sampling rate was needed to achieve good resolution in the waveforms during the startup transient. The motor was connected to the utility through a set of three solid-state relays. This data acquisition and wiring configuration is illustrated in Figure 9.

In order to test the performance of the parameter estimation method, the initial guess of the stator resistance was measured with a multimeter and determined to be 4.1Ω . The magnitudes of the initial guesses of all other parameters were based upon the magnitudes of the parameters from no-load and locked rotor tests; the full set of initial guesses $\hat{\theta}_{init}$ used

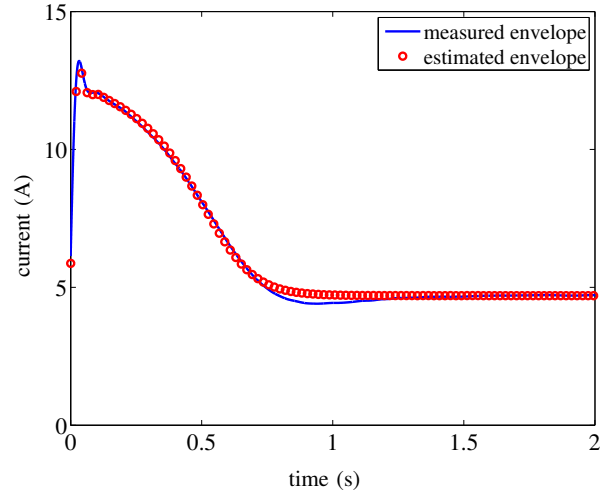

Fig. 10. Plot of the preprocessed observed and estimated phase A motor current envelopes.

to experimentally test the parameter estimation method are provided in the second column of Table I. The parameters of the motor were then estimated using the method described above. The parameter estimation method was implemented in C, and relied particularly upon the GSL libraries [19] for the implementation of many of the algorithms, such as the implementation of the Levenberg-Marquardt algorithm. The speed with which the implemented method was able to determine the parameters ranged from 30 to 90 seconds, depending on the distance between the initial guess and the optimal parameter estimates.

Results using these initial guesses $\hat{\theta}_{init}$ to identify the pre-estimated parameters $\hat{\theta}_{pre}$ are illustrated in Figure 10. As shown by the overlap of the filtered observations and filtered simulations of the phase A stator current $\mathbf{i}_{a,flt}$, the estimated dynamics of the motor current are captured reasonably well in the parameter pre-estimates. The pre-estimated parameters $\hat{\theta}_{pre}$ obtained from this first step are enumerated in the third column of Table I.

Once these pre-estimates of the motor estimates were obtained, they were input to the second step the parameter estimation algorithm, which identified the parameters which minimized the residual between the output of the simulation and the unfiltered set of current observations $\hat{\theta}_{final}$. As with the pre-estimation, the full minimization was tested and validated minimizing only against the observations of the stator current \mathbf{i}_a . The results of this second step are illustrated in Figures 11- 14, and the final parameter estimates are given in the rightmost column in Table I.

The observed current and the estimated current are plotted on two different timescales in Figures 11 and 13; the waveforms in Figure 11 are zoomed in so that the quality of fit can be visually evaluated more easily. It is evident from looking at both sets of plots that the quality of fit is high, as Figure 12 illustrates that the residual $\mathbf{i}_{obs} - \hat{\mathbf{i}}_{est}(\hat{\theta}_{final})$ is within 10% of

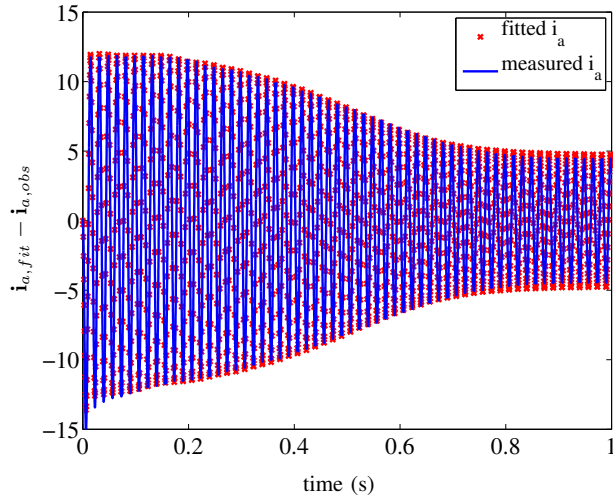

Fig. 11. Observed and fitted observed motor currents.

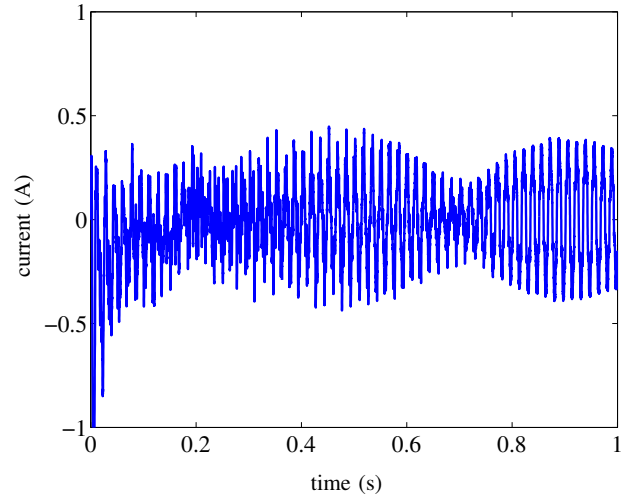

Fig. 12. Residual from $i_{a,fit} - i_{a,obs}$.

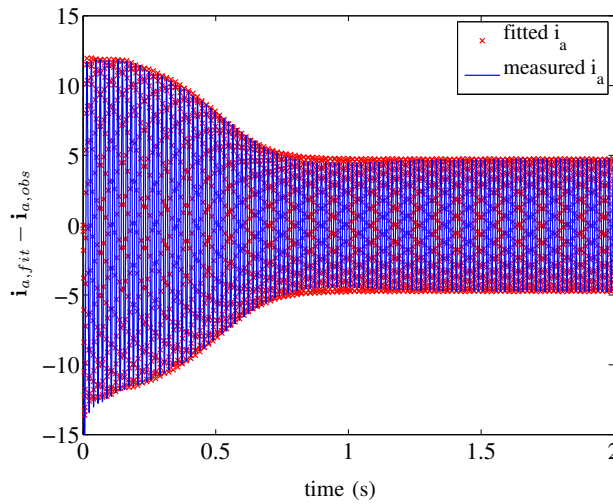

Fig. 13. Observed and fitted observed motor currents over a longer time interval.

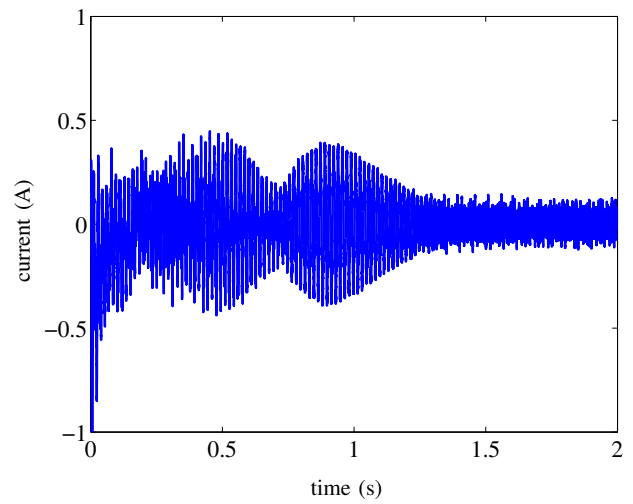

Fig. 14. Residual from $i_{a,fit} - i_{a,obs}$.

the observed current at all points, and within 5% for most. It is also notable that the residual is larger during the initial 1.2 seconds of the motor's operation, and is less than 5% of the waveform during the steady-state operation of the motor. The structure of this residual suggests that these parameters are best-fit parameters and that additional model parameters, such as those that might describe the fact that the actual resistances and reactances change slightly over the course of the startup transient, could be used to further improve the agreement of the fit to the model. The fact that the residual remains below 10% suggests that these effects are not dominant, however, and that this approach to modeling the motor behavior is effective.

IV. DISCUSSION

A method was described in this paper that uses a two-step approach to determine the parameters of an induction machine

Parameter [units]	θ_{init}	θ_{pre}	θ_{final}
R_s [Ω]	4.10	4.10	6.25
R_r [Ω]	1.0	4.19	4.03
X_m [Ω]	10.0	90.72	57.75
X_{ls} [Ω]	1.00	3.78	3.14
X_{lr} [Ω]	1.00	8.26	7.71
β [$\text{N}\cdot\text{m}/(\text{rad}/\text{s})^2$]	1.00e-04	5.69e-04	4.59e-04
K [$1/\text{kg}\cdot\text{m}^2$]	10.00	27.57	31.00

TABLE I
FINAL ELECTRICAL AND MECHANICAL PARAMETERS.

with low-quality initial guesses. The method produces parameters that accurately characterize the machine's behavior. This method was demonstrated to successfully identify parameters

when starting with initial guesses that are as far away from the final parameters as an order of magnitude. Experimental results indicate that this method works well, especially in consideration of measurement noise, unmodeled behavior, and the voltage distortion present on the utility.

This method could be effectively used for a variety of applications, such as condition monitoring or the control of induction machines, as well as the diagnostic analysis of mechanical loads connected to the induction machine. Moreover, the sensitivity of this method to the particular value of the guess is sufficiently small that we suspect that a grid search [20] could be layered on top of this method to identify motor and load combinations that are essentially unknown. Additional research is necessary to implement such an extension of this method and test this hypothesis.

ACKNOWLEDGMENT

The authors would like to thank Professor James Kirtley at MIT and Professor Robert Cox at UNC-Charlotte for their valuable feedback and input.

REFERENCES

- [1] P. Vas, *Sensorless Vector and Direct Torque Control*. Oxford University Press, 1998.
- [2] —, *Parameter Estimation, Condition Monitoring, and Diagnosis of Electrical Machines*. Clarendon Press, 1993.
- [3] H. Toliyat, E. Levi, and M. Raina, "A review of RFO induction motor parameter estimation techniques," *IEEE Transactions on Energy Conversion*, vol. 18, no. 2, pp. 271–283, Jun. 2003.
- [4] L. Ribeiro, C. Jacobina, A. Lima, and A. Oliveira, "Real-time estimation of the electric parameters of an induction machine using sinusoidal PWM voltage waveforms," *IEEE Transactions on Industry Applications*, vol. 36, no. 3, pp. 743–754, May 2000.
- [5] N. Gassara, M. Chaabene, and M. Kamoun, "Smart model for the identification of the induction motor parameters," in *2009 6th International Multi-Conference on Systems, Signals, and Devices*, Mar. 2009.
- [6] K. Wang, J. Chiasson, M. Bodson, and L. Tolbert, "A nonlinear least-squares approach for identification of the induction motor parameters," *IEEE Transactions on Automatic Control*, vol. 50, no. 10, pp. 1622–1628, Oct. 2005.
- [7] K. Kampisios, P. Zanchetta, C. Gerada, and A. Trentin, "Identification of induction machine electrical parameters using genetic algorithms optimization," in *Proceedings of the 2008 Industrial Applications Society Annual Meeting*, Oct. 2008.
- [8] M. Cirrincione, M. Pucci, G. Cirrincione, and G.-A. Capolino, "Constrained minimization for parameter estimation of induction motors in saturated and unsaturated conditions," *IEEE Transactions on Industrial Electronics*, vol. 52, no. 5, pp. 1391–1402, Oct. 2005.
- [9] S. Shaw and S. Leeb, "Identification of induction motor parameters from transient stator current measurements," *IEEE Transactions on Industrial Electronics*, vol. 46, no. 1, pp. 139–149, Feb. 1999.
- [10] C. Laughman, K. Lee, R. Cox, S. Shaw, S. Leeb, L. Norford, and P. Armstrong, "Power signature analysis," *IEEE Power and Energy Magazine*, vol. 1, no. 2, pp. 56–63, Mar. 2003.
- [11] P. Krause, O. Wasynczuk, and S. Sudhoff, *Analysis of Electric Machinery*. McGraw-Hill, 1986.
- [12] S. Shaw and C. Laughman, "A method for nonlinear least squares using structured residuals," *IEEE Transactions on Automatic Control*, vol. 51, no. 10, pp. 1704–1708, Oct. 2006.
- [13] S. Shaw, M. Keppler, and S. Leeb, "Pre-estimation for better initial guesses," *IEEE Transactions on Instrumentation and Measurement*, vol. 53, no. 3, pp. 762–769, Jun. 2004.
- [14] G. Seber and C. Wild, *Nonlinear Regression*, ser. Probability and Mathematical Statistics. Wiley, 1989.
- [15] R. Park, "Two-reaction theory of synchronous machines: Generalized method of analysis, part i," *Transactions of the AIEE*, vol. 48, pp. 716–727, 1929.
- [16] M. Stocks and A. Medvedev, "Estimation of induction machine parameters at start-up using current envelope," *Conference Record of the Industry Applications Conference*, pp. 1163–1170, 13 Oct. 2002.
- [17] R. Supangat, N. Ertugrul, W. Soong, D. Gray, C. Hansen, and J. Grieger, "Detection of broken rotor bars in induction motor using starting-current analysis and effects of loading," *IEEE Proceedings on Electric Power Applications*, vol. 153, no. 6, pp. 848–855, Nov. 2006.
- [18] H. Engl, M. Hanke, and A. Neubauer, *Regularization of Inverse Problems*. Springer, 2000.
- [19] M. Galassi, J. Davies, J. Theiler, B. Gough, G. Jungman, M. Booth, and F. Rossi, *The GNU Scientific Library Manual*, version 1.9 ed., Feb. 2007.
- [20] L. Cooper and D. Steinberg, *Introduction to Methods of Optimization*. Saunders, 1970.